

NOME: _____

TURMA: _____ DATA: ____/____/____

SosProfessorAtividades.com



OS SÍMBOLOS NATALINOS

Você conhece os símbolos natalinos e seus significados?
Vamos conhecer a simbologia por trás dos quinze símbolos mais conhecidos.

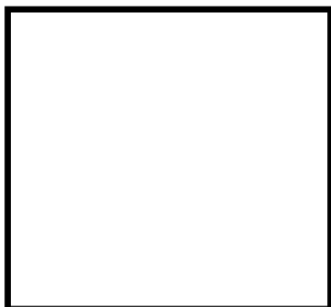

Estrela: a estrela de Natal (Estrela de Belém), foi aquela que indicou aos reis magos onde Jesus estava, pois queriam adorá-lo.

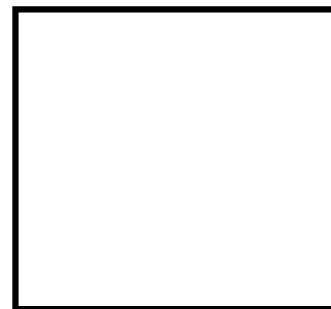

Sino: os sinos de Natal representam o anúncio do nascimento de Jesus.



Vela: simboliza a fé, a luz de Cristo que ilumina a humanidade.

Presépio: Representa o cenário do nascimento de Jesus. O primeiro presépio data de 1223. Foi montado por São Francisco de Assis.

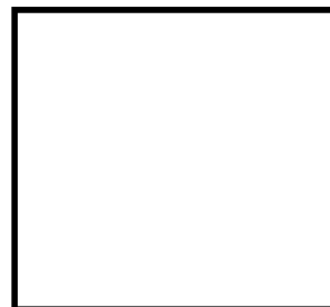

Anjos: são mensageiros que simbolizam o anúncio do nascimento de Jesus.

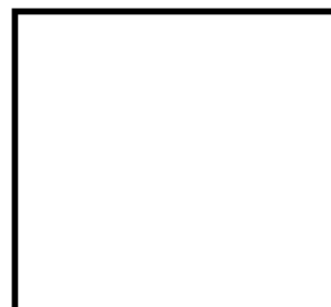

Árvore: a primeira árvore de Natal surgiu no norte da Europa no século XVI.







Papai Noel: a figura do Bom Velhinho surgiu a partir do gesto de bondade de um bispo chamado Nicolau. Segundo a lenda, ele lançava moedas de ouro nas chaminés das casas dos mais necessitados da Turquia.

Coroa do Advento: é uma espécie de guirlanda onde se coloca quatro velas, uma para cada semana que antecede o Natal.





Bolas: as bolas de Natal simbolizam frutos, símbolos da abundância.

Guirlanda: as guirlandas remontam à antiguidade e surgiram em Roma. Elas são um sinal de boas vindas.



Cartão de Natal: os cartões representam o espírito de alegria, agradecimento e partilha inerente a essa época festiva.

Peru: é um dos pratos mais requisitados para a ceia de Natal e que representa fartura.



Ceia: é o símbolo de confraternização e união familiar.

Presentes de Natal: recordam as ofertas dos reis magos ao Menino Jesus.



Panetone: o "pani de Toni" teria surgido de um engano na véspera do Natal. De origem italiana, diz a lenda que Toni, empregado de uma padaria, estava exausto devido ao trabalho decorrente das encomendas de Natal. Por esse motivo, acabou se enganado quando fazia um pão para a ceia da família do seu patrão.

- 1- Qual símbolo natalina é o seu favorito? _____
2- Numere a 2ª coluna de acordo com a 1ª.

- | | |
|----------------|--------------------------------------|
| (1) Vela | () anunciam o nascimento de Jesus. |
| (2) Presépio | () simboliza a fé, a luz de Cristo. |
| (3) Peru | () são mensageiros. |
| (4) Sino | () cenário do nascimento de Jesus. |
| (5) Anjos | () representa fartura. |

3- Dê o significado das palavras sublinhadas.

a) "Bolas: as bolas de Natal simbolizam frutos, símbolos da abundância."

b) "Ceia: é o símbolo de confraternização e união familiar"

4- Copie do texto.

a) Números romanos: _____

b) Nome de um continente: _____

c) Nome de um país: _____

d) Nome de duas cidades: _____

e) Um adjetivo pátrio: _____

f) Cinco substantivos próprios: _____

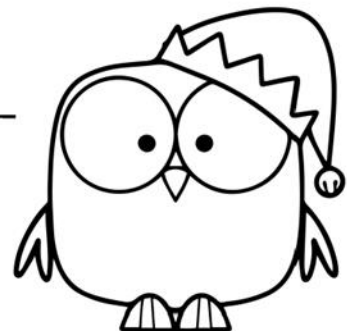

As imagens que devem ser coladas no ao lado do texto.

Aqui tem imagens para dois alunos.

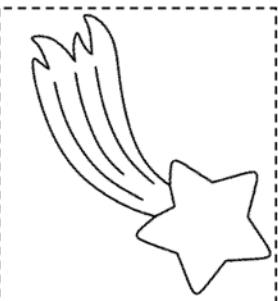
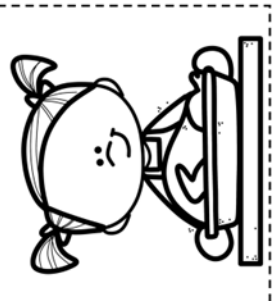
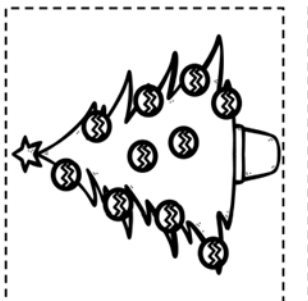
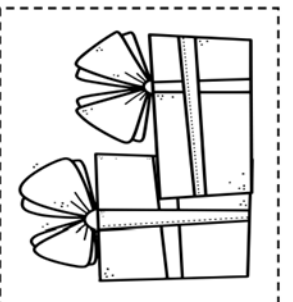
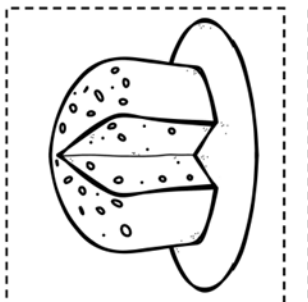
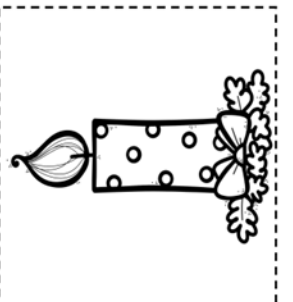
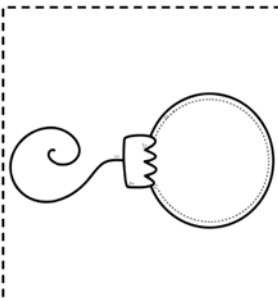
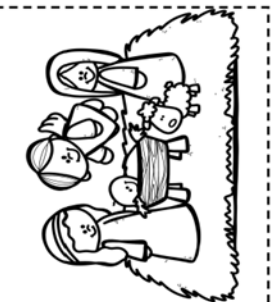
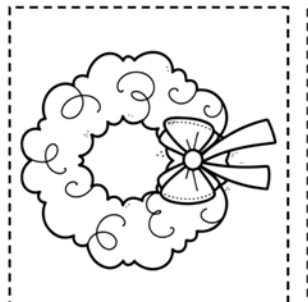
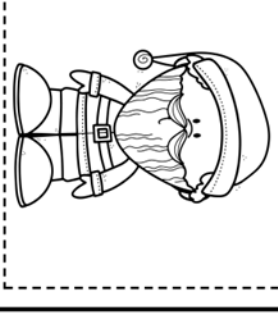
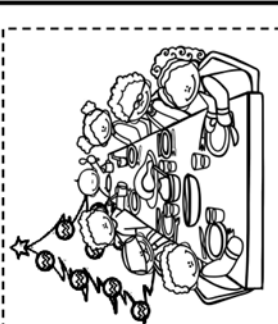
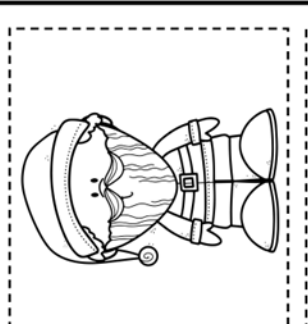
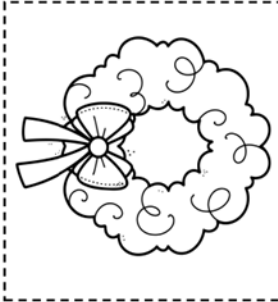
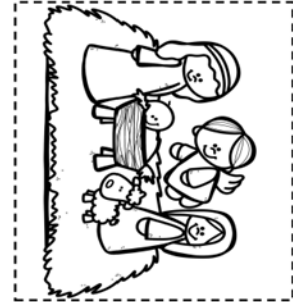
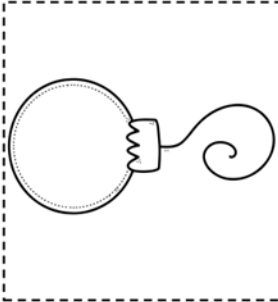
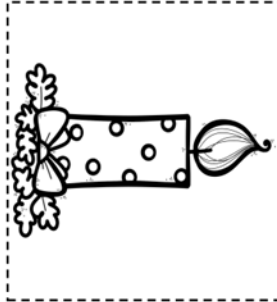
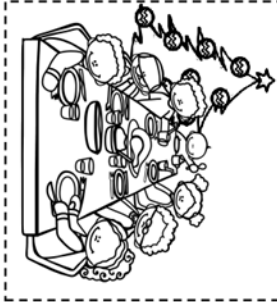
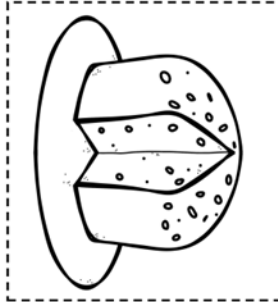
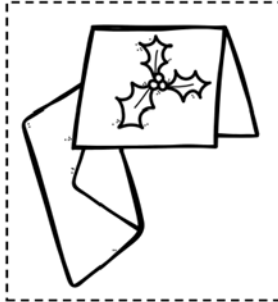
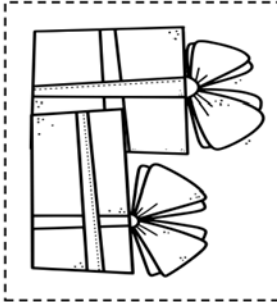
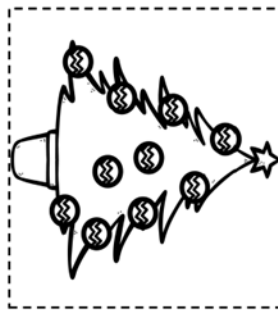
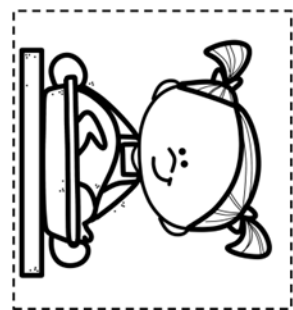
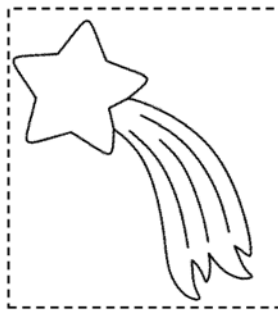
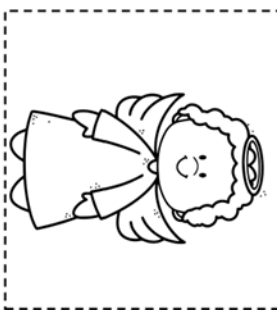

Visite nossas
redes sociais



SOS PROFESSOR
ATIVIDADES

por Betânia Arrimiano



<https://sosprofessoratividades.com>



<https://br.pinterest.com/betasobeta/sosprofessoratividades/>



<https://www.facebook.com/sosprofessoratividades/>



<https://www.instagram.com/sosprofessoratividades/>



https://www.youtube.com/channel/UCxN9wo1jE1txew9bzdO58A?view_as=subscriber

Produção: sosprofessoratividades.com

Todos os direitos reservados ao sosprofessoratividades.com. É proibido distribuir, reproduzir ou vender este material por qualquer meio, seja eletronicamente ou impresso, bem como reivindicá-lo como seu e tentar modificar ou remover avisos de direitos autorais, logotipos ou marcas d'água, uma vez que é protegido por direitos autorais. O não cumprimento é uma violação da Lei de Direitos Autorais e pode ter consequências legais. Lei dos direitos autorais, nº 9.610/98

Cliparts que utilizo:

